



**Probing Solutions.  
Made in Germany.**



**Lambda**

[www.lambdaphoto.co.uk](http://www.lambdaphoto.co.uk)



# FireFly<sup>®</sup> Series

## High Voltage Optically-Isolated Probes with Universal BNC Interface

>1.5 GHz, >180dB CMRR

## About FireFly® Series

---

The FireFly® high voltage optically isolated probes offer industry leading performance that combines the ability to accurately resolve high bandwidth, small differential signals in the presence of large common mode voltages with its ultra-high common mode rejection performance across its entire bandwidth. With >1.5GHz bandwidth, wide differential input range, unmatched common mode rejection ratio CMRR up to >180dB (1 billion to 1 rejection), and a 60kV common mode, FireFly® is the ideal measurement solution for both GaN and SiC device characterization and system level design development.

PMK's optically isolated interface and unique compact angled probe head design are the key attributes that set FireFly® apart from the other solutions in the market, providing very stable and accurate measurements over a wide temperature range and easy access to the measurement points in tight spaces.

The compact angled probe head design allows for shorter tip cables to be used, resulting in higher signal fidelity measurements and reduced stresses placed on the measurement test point. FireFly®'s wide selection of probe tip connections and accessories offer reliable, hands-free, high-fidelity connectivity to the measurement points. Using industry standard MMCX and square pins connections allow FireFly® to easily interface to test boards that have already been designed with these test points.

FireFly® has a universal BNC output connector and is compatible with any oscilloscope with a 50Ω input impedance or 1MΩ input impedance and a 50Ω feed-through termination, allowing FireFly® to be used on any oscilloscope in the lab.

For accurate deskew, each probe's unique propagation delay is measured and added to each probe label.

The FireFly® probe head can be powered either with a power-over-fiber adapter for 24/7 continuous operation (FF-1500A-10m is not compatible with FF-POF-A01) or by an easy to change, rechargeable, industry standard 18650 battery that provides continuous operation for up to 30h at room temperature. The interface box is powered in both cases by the required PMK power supply. The multichannel power supplies all have remote control capabilities and therefore a USB interface and optional additional LAN interface. As an alternative for most flexible use, the 1 channel battery pack power supply AP-01 provides >8h of portable and isolated operation but has no software remote control.

FireFly® series has the capability to be controlled from either remote control, or the controls located on the interface box.

For remote control PMK offers the software "PMK Probe Control" with graphical user interface, which is shipped with any multichannel power supply, and is available for download at:

<http://www.pmk.de/en/products/probecontrol>

In addition, the Python package "PMK-probes" is available as a programming interface for controlling PMK's active probes. Installation instructions, examples and documentation can be found here:

<https://pmk-probes.readthedocs.io/en/latest/>

## Specifications

Read the Instruction Manual before first use and keep it for future reference. A digital copy of the latest Instruction Manual revision can be downloaded at [www.pmk.de](http://www.pmk.de)

Specifications that are marked with \* are guaranteed, others are typical. Do not exceed specifications. Allow the probe to warm up for 20 minutes. The probe head and tip cables are not for handheld use. The probe can be used without the probe tip. To achieve the most accurate measurement results, review the "Getting Started" section in the Instruction Manual. This probe comes with 1 year warranty.

## Electrical Specifications<sup>1</sup>

Observe adequate spacing between probe head components and earth ground. This product is not rated for CAT II, III or IV. Do not exceed the specifications. Use original PMK power supplies only.

FireFly®	Bandwidth * (-3dB)	Rise time * (10% - 90%)	Input Attenuation	Input Impedance <sup>2</sup>
SMA Input	> 1.5 GHz	<250 ps	1X	200 kΩ    5.1 pF
FF-MMCX-1V	> 1.5 GHz	<250 ps	1X	50 Ω <sup>3</sup>
FF-MMCX-10V	> 1.3 GHz	<280 ps	10X	2 MΩ    3.4 pF
FF-MMCX-25V	> 1.3 GHz	<280 ps	25X	4.9 MΩ    2.1 pF
FF-MMCX-50V	> 1.3 GHz	<280 ps	50X	10 MΩ    2 pF
FF-MMCX-100V	> 1.3 GHz	<280 ps	100X	9.5 MΩ    2.1 pF
FF-MMCX-250V	> 1.3 GHz	<280 ps	250X	20 MΩ    2.1 pF
FF-WSQ-500V	> 1.0 GHz	<300 ps	500X	40 MΩ    2.8 pF
FF-WSQ-1000V	> 1.0 GHz	<300 ps	1000X	40 MΩ    2.9 pF
FF-WSQ-1500V	> 1.0 GHz	<300 ps	1500X	40 MΩ    2.7 pF
FF-WSQ-2500V	> 1.0 GHz	<300 ps	2500X	40 MΩ    2.5 pF

### Maximum Rated Input Voltages <sup>4</sup>

Common Mode Voltage <sup>5</sup> (Maximum Voltage to Earth)	± 60 kV (DC + Peak AC)	
No Measurement Category	Linear Input Voltage Range (DC + Peak AC) <sup>2</sup>	Maximum Non-Destruct Differential Input Voltage (DC + Peak AC) <sup>2</sup>
SMA Input	± 1 V	5 V
FF-MMCX-1V	± 1 V	5 V
FF-MMCX-10V	±10 V	50 V
FF-MMCX-25V	± 25 V	100 V
FF-MMCX-50V	± 50 V	100 V
FF-MMCX-100V	± 100 V	200 V
FF-MMCX-250V	± 250 V	300 V
FF-WSQ-500V	± 500 V	3000 V **
FF-WSQ-1000V	± 1000 V	3000 V **
FF-WSQ-1500V	± 1500 V	3000 V **
FF-WSQ-2500V	± 2500 V	3000 V **
Pollution Degree	2	

See next page for more Electrical Specifications and footnotes.

## Electrical Specifications (Continued)

Common Mode Rejection Ratio	DC	1 MHz	100 MHz	200 MHz	500 MHz	1 GHz
<b>SMA Input</b>	> 180 dB	165 dB	124 dB	122 dB	121 dB	118 dB
<b>FF-MMCX-1V</b>	> 180 dB	153 dB	113 dB	110 dB	109 dB	107 dB
<b>FF-MMCX-10V</b>	> 180 dB	144 dB	105 dB	100 dB	97 dB	95 dB
<b>FF-MMCX-25V</b>	> 180 dB	137 dB	91 dB	87 dB	86 dB	86 dB
<b>FF-MMCX-50V</b>	> 180 dB	132 dB	86 dB	83 dB	80 dB	81 dB
<b>FF-MMCX-100V</b>	> 180 dB	126 dB	80 dB	77 dB	72 dB	70 dB
<b>FF-MMCX-250V</b>	> 180 dB	122 dB	75 dB	71 dB	69 dB	68 dB
<b>FF-WSQ-500V</b>	> 180 dB	101 dB	63 dB	60 dB	51 dB	49 dB
<b>FF-WSQ-1000V</b>	> 180 dB	94 dB	59 dB	56 dB	46 dB	42 dB
<b>FF-WSQ-1500V</b>	> 180 dB	91 dB	55 dB	51 dB	43 dB	35 dB
<b>FF-WSQ-2500V</b>	> 180 dB	89 dB	52 dB	45 dB	41 dB	32 dB
<b>DC Gain Accuracy</b>	< 2 % ± DC Offset voltage					
<b>Noise (input referred)</b>	FF-1500A (2 m fiber cable): SMA Input (1X): < 2 mV rms		FF-1500A-10m (10 m fiber cable): SMA Input (1X): < 3 mV rms			
	<i>With tip cable: (SMA Input noise) · (Tip cable input attenuation)<sup>7</sup> scales proportionally to tip attenuation</i>					
<b>DC Offset Voltage (input referred)</b>	SMA Input (1X): < 1.5 mV (After Auto-Zero) <sup>8</sup> <i>With tip cable: (SMA Input offset voltage) · (Tip cable input attenuation)<sup>9</sup> scales proportionally to tip attenuation</i>					
<b>Temperature Drift</b>	< 0.05%/°C					
<b>Propagation Delay</b>	2 m fiber cable: 15 ns		10 m fiber cable: 55 ns			
	<i>The probe specific value is measured and printed on interface box label, tip cable approx. 500 ps</i>					
<b>Battery Life</b>	> 30 h @ 22 °C – 25 °C, > 20 h @ 0 °C, > 4 h @ 50 °C <i>Dependent on probe head operating temperature (Continuous Operation)</i>					
<b>Output Termination &amp; Coupling</b>	50 Ω DC					
<b>Battery Type</b>	Protected 18650 Li-Ion, Rechargeable, 3.7V Certified					
<b>Laser Certification</b>	Laser Class 1 IEC/EN 60825-1:2014, US 21CFR Part 1010, US 21CFR Part 1040					

### Notes:

\* Guaranteed specification

\*\* Preliminary specification

<sup>1</sup> Determined when using a PS-02 power supply at +23°C ambient temperature.

<sup>2</sup> For input voltage and input impedance derating graphs review the FireFly® instruction manual.

<sup>3</sup> Terminated, 50 Ω transmission line.

<sup>4</sup> As defined in IEC 61010-1. Rated for indoor, dry location use only.

<sup>5</sup> Galvanically isolated FireFly® probe head through fiber optic connection.

<sup>6</sup> CMRR performance is >180dB below 100kHz. See CMRR graph.

<sup>7</sup> Example: 10x tip FF-MMCX-10V noise = 10x SMA input noise.

<sup>8</sup> For long cable versions, the DC offset is more sensitive, so do not move the fiber cable during measurements.

<sup>9</sup> Example: 10x tip FF-MMCX-10V offset = 10x SMA input offset.

## Environmental Specifications

Parameter	Specification		
Temperature Range	Operating	Probe Head	0 °C to +50 °C
		Interface Box	0 °C to +40 °C
		Tip Cables & Adapters	-40 °C to +85 °C
	Non-Operating	Probe Head & Interface Box	-20 °C to +71 °C
Tip Cables & Adapters		-40 °C to +85 °C	
Maximum Relative Humidity	Operating	Probe Head	5 % to 85 % RH (relative humidity) at up to +40 °C, 5 % to 45 % RH above +40 °C up to +50 °C, non-condensing
		Interface Box	5 % to 85 % RH (relative humidity) at up to +40 °C, non-condensing
	Non-Operating	Tip Cables & Adapters	5% to 85% RH (relative humidity) at up to +85 °C, non-condensing
		Probe Head & Interface Box	5 % to 85 % RH (relative humidity) at up to +40° C, 5 % to 45 % RH above +40° C up to +71° C, non-condensing
Maximum Altitude	Operating		3000 m (9843 ft)
	Non-Operating		15000 m (49213 ft)

## Physical Specifications

Parameter	Specification	
Weight	Probe	2 m: 325 g / 10 m: 625 g
	Tip Cable	11 g
Length	Tip Cable	9.5 cm (3.74")
	Fiber Cable	2 m (6.56 ft) / 10 m (32.81 ft)
Connectors	Probe	Input: SMA (Female) – Probe Head Output: BNC (Male) - Interface Box

## Dimensions

The dimensions shown are in mm. If a specific drawing is needed, please contact us via [sales@pmk.de](mailto:sales@pmk.de)

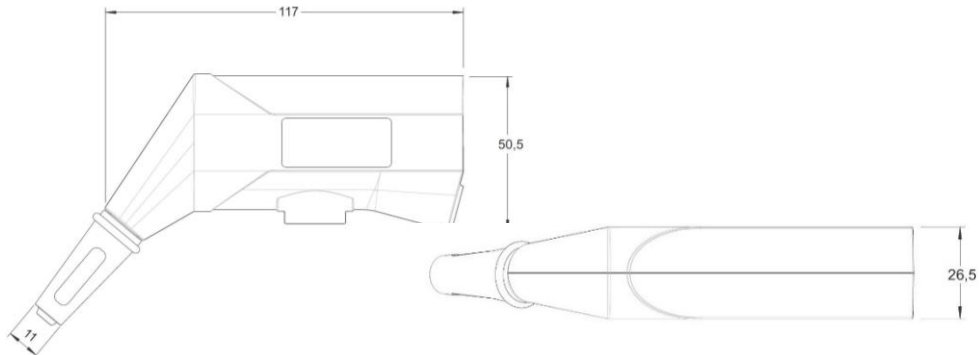

## Typical Common Mode Rejection Ratio (CMRR)

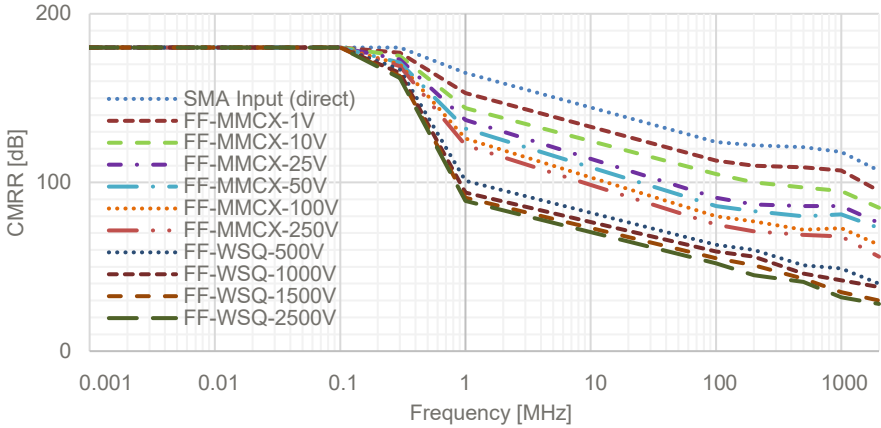

## Typical Frequency Response

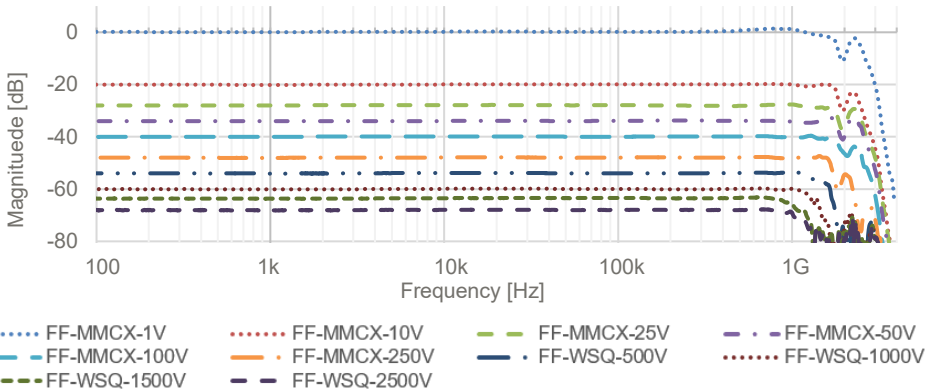

## Typical Maximum Differential Input Voltage (CW)



Note that the maximum input voltage rating of the probe decreases as the frequency of the applied signal increases.

*The maximum input voltage derating is coming soon.*

## Typical Pulse Response

The graphs are normalized to 1 for better comparison.

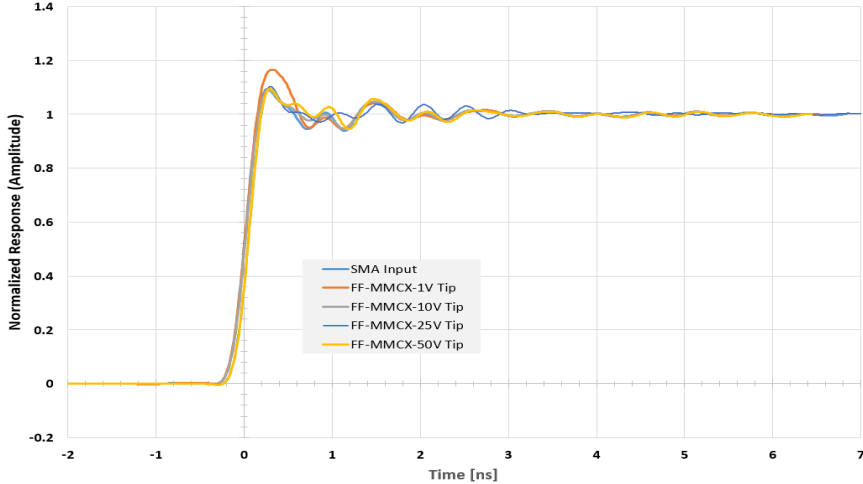

## Typical Differential Input Impedance



Note that the maximum input voltage rating of the probe decreases as the frequency of the applied signal increases.

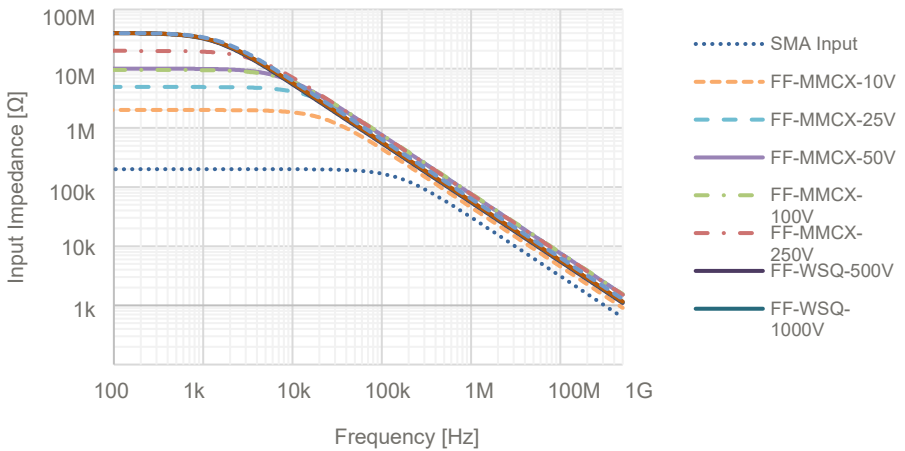

## Probe Accessory Ratings



Do not exceed any accessory rating or the ratings of other components of this product series.



For high-frequency voltage measurements

### MMCX Adapter to 3x square pin holes (-) (+) (-), 2.54mm pitch each (018-294-270)

<b>Maximum Rated Input Voltage</b>	42V peak, 30 V rms, 60 V DC
<b>Pollution Degree</b>	2



The following ratings are only valid for non-handheld use in the hazard zone:

<b>Maximum Rated Input Voltage:</b>	130V DC + AC pk, 400V pulse
<b>Pollution Degree:</b>	2

### MMCX Adapter to 2x square pin holes (+) (-), 2.54mm pitch (018-294-276)

<b>Maximum Rated Input Voltage</b>	42V peak, 30 V rms, 60 V DC
<b>Pollution Degree</b>	2



The following ratings are only valid for non-handheld use in the hazard zone:

<b>Maximum Rated Input Voltage:</b>	130V DC + AC pk, 400V pulse
<b>Pollution Degree:</b>	2

### Extension lead for FireFly® HV tips (5.08mm pitch) to 2x 4mm safety (male) banana plugs (FF-WSQ-4mm-2, Set of 2)

<b>Maximum Rated Input Voltage</b>	42V peak, 30 V rms, 60 V DC
<b>Pollution Degree</b>	2



The following ratings are only valid for non-handheld use in the hazard zone:

<b>Maximum Rated Input Voltage *:</b>	2500 V DC + AC pk, 3000V pulse
<b>Pollution Degree:</b>	2

### Extension lead for FireFly® HV tips (5.08mm pitch) to Ø4mm opening spades (FF-WSQ-SPADE-2, Set of 2)

<b>Maximum Rated Input Voltage</b>	42V peak, 30 V rms, 60 V DC
<b>Pollution Degree</b>	2



The following ratings are only valid for non-handheld use in the hazard zone:

<b>Maximum Rated Input Voltage *:</b>	2500 V DC + AC pk, 3000V pulse
<b>Pollution Degree:</b>	2



Observe the minimum required distance between contacts.

#### Notes:

\* Observe input voltage range of the FireFly probe tip. See Electrical Specification table in this document.

## Scope of Delivery

Not all required items are included in the scope of delivery of the base probe FireFly® FF-1500A/FF-1500A-10m. See Ordering Information to configure your individual probing solution and select a required PMK power supply. The following is included in the scope of delivery.

- **FF-1500A / FF-1500A-10m** FireFly® base probe,  $\pm 1V$  input range
- **890-520-900** Interface box probe connection cable (0.6m)
- **FF-2FOOTERA** Probe head holder 2-Footer (Bi-Pod), strong magnetic holding force
- **891-102-CMRR** CMRR Noise Suppression Kit for FireFly®
- 2x 18650 rechargeable Lithium-Ion batteries
- USB Wall charger + USB cable (for battery charging) *Charger type may vary by region*
- Set cable coding rings (3x4 colors)
- Carrying case (black, plastic)
- Instruction Manual
- Safety Information
- Factory calibration certificate



The accessories for this probe series have been safety tested.  
Do not use any other accessories, batteries or power supplies than what is recommended.

## Ordering Information

### Step 1: Select Probe Head

<b>FF-1500A</b>	FireFly® optical isolated probe, 1.5GHz, >180dB, 2m fiber cable (2 batteries and 2footer included, required power supply to be ordered separately)
<b>FF-1500A-10m</b>	FF-1500A with 10m fibre cable
<b>FF-POF-A01</b>	Power-Over-Fiber adapter for 24/7 continuous operation of the 2m FireFly®'s probe head without using the 18650 battery at room temperature. One additional power supply channel is required. FF-1500A required



The POF adapter is not compatible with the 10m FF-1500A-10m.

### Step 2: Select Probe Tip Cables

The probe tip cables are interchangeable without requiring any tools. The probe head SMA input range is  $\pm 1V$  with no attenuation. Also review our new ultra-fast current shunt series UFCS on [www.pmk.de](http://www.pmk.de).

<b>FF-MMCX-1V</b>	FireFly® probe tip cable, MMCX, $\pm 1V$ , >1.5GHz, 1x attenuation, 50 $\Omega$ terminated for shunt measurements
<b>FF-MMCX-10V</b>	FireFly® probe tip cable, MMCX, $\pm 10V$ , >1.3GHz, 10x attenuation
<b>FF-MMCX-25V</b>	FireFly® probe tip cable, MMCX, $\pm 25V$ , >1.3GHz, 25x attenuation
<b>FF-MMCX-50V</b>	FireFly® probe tip cable, MMCX, $\pm 50V$ , >1.3GHz, 50x attenuation
<b>FF-MMCX-100V</b>	FireFly® probe tip cable, MMCX, $\pm 100V$ , >1.3GHz, 100x attenuation
<b>FF-MMCX-250V</b>	FireFly® probe tip cable, MMCX, $\pm 250V$ , >1.3GHz, 250x attenuation
<b>FF-WSQ-500V</b>	FireFly® probe tip cable for 5.08mm square pins, $\pm 500V$ , >1.0GHz, 500x
<b>FF-WSQ-1000V</b>	FireFly® probe tip cable for 5.08mm square pins, $\pm 1kV$ , >1.0GHz, 1000x
<b>FF-WSQ-1500V</b>	FireFly® probe tip cable for 5.08mm square pins, $\pm 1.5kV$ , >1.0GHz, 1500x
<b>FF-WSQ-2500V</b>	FireFly® probe tip cable for 5.08mm square pins, $\pm 2.5kV$ , >1.0GHz, 2500x

## Step 3: Select Connectivity Accessories

Observe the frequency derating of each accessory. Observe maximum input voltage of the probe's input. Do not use any other accessories.

### 018-294-270

Adapter MMCX to 3x square pin holes with 2.54mm pitch each (-) (+) (-)  
for high-frequency voltage measurements

Also available as packs: 10pcs **018-294-270x10**, 25pcs **018-294-270x25**



### 018-294-276

Adapter MMCX to 2x square pin holes with 2.54mm pitch each (-) (+)  
for high-frequency voltage measurements

Also available as packs: 10pcs **018-294-276x10**, 25pcs **018-294-276x25**



### FF-SQ-MMCX5

5x MMCX to 2x 0.025" (0.635mm) socket, -40°C to +125°C

### FF-HTSPAD-MMCX3

3x MMCX solder-in cable adapter HT, 50Ω RF micro coax  
to flex solder-in pad, -40°C to +155°C (green = 0Ω, yellow = 36Ω, red = 75Ω)  
Probe tip solder-in adapters have different damping resistor values to reduce  
eventually occurring ringing/oscillations:

0 Ω = no damping

36 Ω = light to medium damping

75 Ω = heavy damping



### FF-HTS-MMCX2

2x MMCX solder-in cable adapter HT, MMCX socket with  
50Ω RF micro coax cable and open end, -40°C to +155°C

### FF-UFL-MMCX2

2x MMCX cable adapter, MMCX socket with 50Ω RF micro  
coax cable to UFL socket, -40°C to +125°C



### FF-2XR-MMCX

MMCX to 2x XR Mini-Hook

### FF-WSQ-4mm-2

2x extension lead for FireFly® HV tips (5.08mm pitch)  
to 2x 4mm safety banana plugs (male), e.g. to use  
BumbleBee® series accessories

### FF-WSQ-SPADE-2

2x extension lead for FireFly® HV tips (5.08mm pitch)  
to spades (Ø4mm opening)

### FF-MMCX-SPADE-3

3x extension lead for FireFly® MMCX tips  
to spades (Ø4mm opening)



**972416100** 2-pole test clip SMD for use with FF-SQ-MMCX5

**P25-2** Pico Hook™ red for use with FF-SQ-MMCX5

**P25-0** Pico Hook™ black for use with FF-SQ-MMCX5

**D010031** 50Ω BNC feed-through for 1MΩ input oscilloscopes



## Step 4: Select Shunt for Current Measurements

Each resistance model is available as single pack or as more cost-effective packs with 10 or 25 pieces.

The UFCS shunt needs 50Ω termination, so an input tip cable with 50Ω termination is required for use with these shunts, e.g. the 1X FF-MMCX-1V. The Shunts all have a 50Ω female SMA output, so an SMA to MMCX adapter is needed as well.

**UFCS-R001** 1 mΩ, >600 MHz bandwidth, 120 pH insertion inductance, 1250 A maximum pulse current @ 100μs, SMA (F) output, 1 pc.  
Also available as packs: 10 pcs **UFCS-R001x10**, 25 pcs **UFCS-R001x25**



**UFCS-R005** 5 mΩ, >900 MHz bandwidth, 140 pH insertion inductance, 300 A maximum pulse current @ 100 μs, SMA (F) output, 1 pc.  
Also available as packs: 10 pcs **UFCS-R005x10**, 25 pcs **UFCS-R005x25**



**UFCS-R011** 11 mΩ, >1GHz bandwidth, 110 pH insertion inductance, 105 A maximum pulse current @ 100 μs, SMA (F) output, 1 pc  
Also available as packs: 10 pcs **UFCS-R011x10**, 25 pcs **UFCS-R011x25**



**UFCS-R024** 24 mΩ, >1GHz bandwidth, 140pH insertion inductance, 70A maximum pulse current @ 100μs, SMA (F) output, 1pc  
Also available as packs: 10pcs **UFCS-R024x10**, 25 pcs **UFCS-R024x25**



**UFCS-R052** 52 mΩ, >900 MHz bandwidth, 150 pH insertion inductance, 50 A maximum pulse current @ 100 μs, SMA (F) output, 1 pc  
Also available as packs: 10 pcs **UFCS-R052x10**, 25 pcs **UFCS-R052x25**



**018-291-970** Adapter for use of UFCS series shunts with FireFly® series.  
SMA plug to MMCX socket, 50Ω



## Step 5: Select Positioning System

**FF-3DPOS200A** FireFly® 3D Probe Positioner for 10kV Insulation with steel base (893-100-001), arm with span width 200mm (893-200-200), FireFly® non-conducting probe holder (FF-HAL10kV-A), Wrench 7mm, strong magnetic holding force



**FF-HAL10kV-A3** FireFly® non-conducting probe holder, max 10kV for use with PMK's 3D Probe Positioning Systems and SKID Probes and PCB Board holder systems, strong magnetic holding force, pack of 3 – spare parts







**FF-2FOOTERA** FireFly® positioner 2-Footer (Bipod), non-conducting, strong magnetic holding force - included in probe's scope of delivery

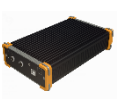

## Step 6: Select Power Supply

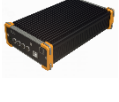
A PMK multi-channel power supply is required for using the probe, also when powering the probe head with the optional Power-over-Fiber adapter FF-POF-A01 instead of an 18650 battery.

<b>889-09V-PS2</b>	2ch power supply PS-02 with USB for remote and offset control	
<b>889-09V-PS2-L</b>	2ch power supply PS-02-L with LAN and USB for remote and offset control	
<b>889-09V-PS3</b>	4ch power supply PS-03 with USB for remote and offset control	
<b>889-09V-PS3-L</b>	4ch power supply PS-03-L with LAN and USB for remote and offset control	
<b>889-09V-PS6</b>	8ch power supply PS-06 with USB for remote and offset control	
<b>889-09V-PS6-L</b>	8ch power supply PS-06-L with LAN and USB for remote and offset control	
<b>889-09V-AP01</b>	1ch Battery pack AP-01, no remote or offset control capabilities	
<b>890-520-900</b>	Power supply cable 0.6m <i>Included with the probe</i>	
<b>890-520-915</b>	Power supply cable 1.5m	

Observe Connector Pin-Out for PMK power supply cables



The power supply pin assignment is different from other power supplies. Use only original PMK power supplies with PMK probes.

## Step 7: Select Accredited Calibration

**KAL-DAKKS-FF**      ISO 17025 (re-)calibration

## Step 8: Select Additional Accessories

**D010031**      50Ω BNC feedthrough for use with 1MΩ oscilloscope inputs, 0.5W

If you need any non-published accessory, please contact us via [sales@pmk.de](mailto:sales@pmk.de)







Distribution in the UK & Ireland



**Characterisation,  
Measurement &  
Analysis**

**Lambda Photometrics Limited**

Lambda House Batford Mill

Harpenden Herts AL5 5BZ

United Kingdom

**E: [info@lambdaphoto.co.uk](mailto:info@lambdaphoto.co.uk)**

**W: [www.lambdaphoto.co.uk](http://www.lambdaphoto.co.uk)**

**T: +44 (0)1582 764334**

**F: +44 (0)1582 712084**

**Copyright © 2025 PMK - All rights reserved.**

Information in this publication supersedes that in all previously published material.  
Specifications are subject to change without notice.

Informationen in dieser Anleitung ersetzen die in allen bisher veröffentlichten Dokumenten.  
Änderungen der Spezifikationen vorbehalten.